

ASSEMBLY PART NUMBER	COLOR	KEYING OPTION	DIMENSIONS (DEGREES)		CAVITY TYPE & STATUS (X = PLUGGED)			
			A	B	1	2	3	4
33482-0401	BLACK	A	60	60				
33482-0402	LIGHT GRAY	B	40	60				
33482-0403	DARK GRAY	C	60	40				
33482-0404	STONE GRAY	D	40	40				
33482-0406	BLACK	A	60	60		X		
33482-0407	LIGHT GRAY	B	40	60		X		
33482-0408	DARK GRAY	C	60	40		X		
33482-0409	STONE GRAY	D	40	40		X		
33482-0411	BLACK	A	60	60		X	X	
33482-0412	LIGHT GRAY	B	40	60		X	X	
33482-0413	DARK GRAY	C	60	40		X	X	
33482-0414	STONE GRAY	D	40	40		X	X	
33482-0416	BLACK	A	60	60	X	X	X	X
33482-0417	LIGHT GRAY	B	40	60	X	X	X	X
33482-0418	DARK GRAY	C	60	40	X	X	X	X
33482-0419	STONE GRAY	D	40	40	X	X	X	X
33482-0421	BLACK	A	60	60	X	X	X	
33482-0422	BLACK	A	60	60				X
33482-0423	BLACK	A	60	60			X	X
33482-0424	BLACK	A	60	60			X	

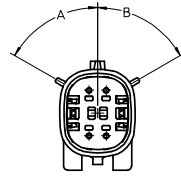

KEYING OPTION
SEE TABLE
SCALE 2:1

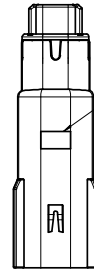

OPTIONAL TRACEABILITY
INFORMATION LOCATED IN
THIS AREA

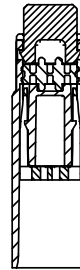

SECTION A-A

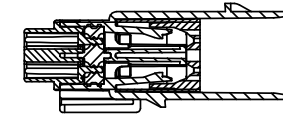
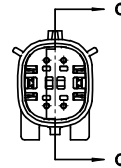
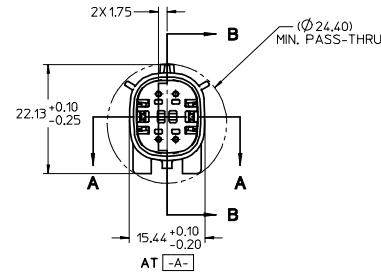

(BLADE INSERT SHOWN IN FULL-LOCK POSITION)
SEE NOTE 2

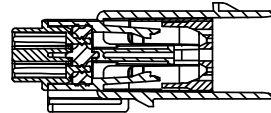

(BLADE INSERT SHOWN IN PRE-LOCK POSITION)
SEE NOTE 2

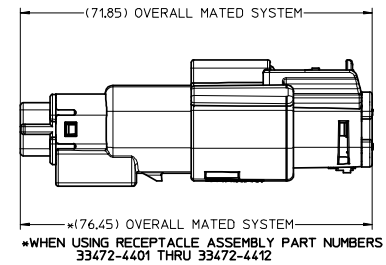

*WHEN USING RECEPTACLE ASSEMBLY PART NUMBERS
33472-4401 THRU 33472-4412

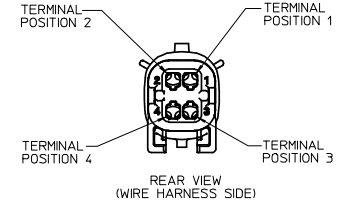

REAR VIEW
(WIRE HARNESS SIDE)

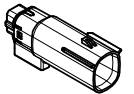

SCALE 1:1

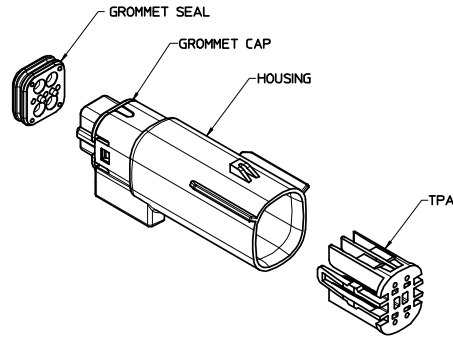

NOTES: UNLESS OTHERWISE SPECIFIED

- DESIGNED TO MATE WITH RECEPTACLE HOUSING ASSEMBLY SPECIFIED IN MOLEX CHARTED DRAWING SD-33472-041.
- ASSEMBLY SHIPPED WITH BLADE INSERT IN PRE-LOCK POSITION (SEE SECTION C-C PRE-LOCK). UPON FULL TERMINAL ASSEMBLY, EACH BLADE INSERT MUST BE SNAPPED INTO ITS FINAL-LOCK POSITION.
- FOR BLADE TERMINALS TO BE USED WITH THIS ASSEMBLY, SEE DRAWING SD-33000-001.
- SYSTEM TO BE USED WITH WIRE WITHIN DIAMETER RANGE OF 1.5mm TO 2.5mm.
- MATERIAL: SPS/NYLON BLEND, 20% GLASS FILLED.
- CHENGDU ASSEMBLIES SHALL CONFORM TO PACKAGING SPECIFICATION PK-31300-635
- SHALL CONFORM TO PRODUCT SPECIFICATION PS-33472-000.

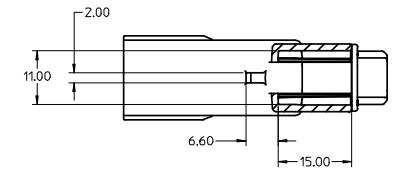
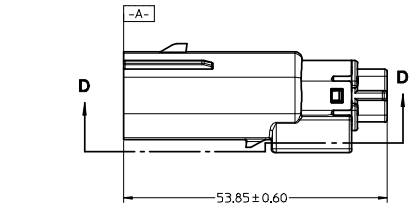

SECTION D-D

REDRAWN EC NO. UAU2008-0599 DRAWN/DRAWN/CHKD BY CHYK/SVERZYL 2008/03/24 APPR./SMARCEAU 2008/03/24	QUALITY SYMBOLS ▽=0 ▽=0	GENERAL TOLERANCES (UNLESS SPECIFIED)		DIMENSION STYLE MM ONLY	SCALE 2:1	DESIGN UNITS METRIC	THIRD ANGLE PROJECTION		
		4 PLACES ± mm ± INCH 3 PLACES ± --- ± --- 2 PLACES ± 0.10 ± --- 1 PLACE ± 0.3 ± ---	DRAWN BY MYANSLAMBROU 04-27-06 CHECKED BY DGRIFITHS 06-22-06 APPROVED BY SMARCEAU 06-22-06	DATE	DATE	TITLE MX150 BLADE CONNECTOR ASSEMBLY 2 ROW SEALED 4 WAY	MATERIAL NO. SEE TABLE	DOCUMENT NO. SD-33482-041	SHEET NO. 1 OF 1
		DRAFT WHERE APPLICABLE MUST REMAIN WITHIN DIMENSIONS	MOLEX INCORPORATED THIS DRAWING CONTAINS INFORMATION THAT IS PROPRIETARY TO MOLEX INCORPORATED AND SHOULD NOT BE USED WITHOUT WRITTEN PERMISSION						